

# Catchbox Plus

## Technical Specifications



Catchbox Plus is a wireless microphone system featuring Cube throwable mic, Clip lavalier mic and Hub receiver. Plus system is designed for both - mobile plug & play setups and complex multi-room installations in medium to large rooms. Compatible accessories ensure flexibility, hassle-free maintenance and secure installation. Catchbox Plus is ideal for voice amplification and hybrid setups in lectures, meetings and events.

### General Specifications

<b>Audio latency</b>	12 ms
<b>Audio encryption</b>	AES128
<b>Radio frequency band</b>	DECT / DECT 6.0 (1.8 / 1.9 GHz band) We will ship the product according to your provided shipping address
<b>Radio output power</b>	Up to 100 mW, controllable from Hub
<b>Max # of transmitters in one space</b>	EU: up to 10, US: up to 6
<b>Wireless range</b>	100 m / 330 ft (Line of Sight)*
<b>Operating temperature range</b>	0 °C (32 °F) to 30 °C (86 °F)

\* The actual operating range depends upon the RF output settings, the surroundings, the signal absorption, signal reflection and signal interference

### Hub

Two mic channel receiver with a graphical UI and built-in mixing capabilities.

<b>Audio outputs</b>	Mic 1 - XLR - balanced, Mic level Mic 2 - XLR - balanced, Mic level Mix output - USB-C - digital output Mix output - RCA - unbalanced, Line level
<b>Audio inputs</b>	USB-C - digital input Aux-in - 3.5mm - unbalanced, Line level
<b>Dante™ audio networking</b>	<b>PRO</b>
<b>API / Remote monitoring</b>	<b>PRO</b>
<b>Antenna type</b>	Built-in antennas
<b>Kensington lock</b>	Yes
<b>Stealth mode</b>	Yes
<b>Weight (without Wall mounting kit)</b>	300 g / 10.58 oz
<b>Dimensions (without Wall mounting kit)</b>	184 x 92 x 40 mm / 7.2 x 3.6 x 1.6 in

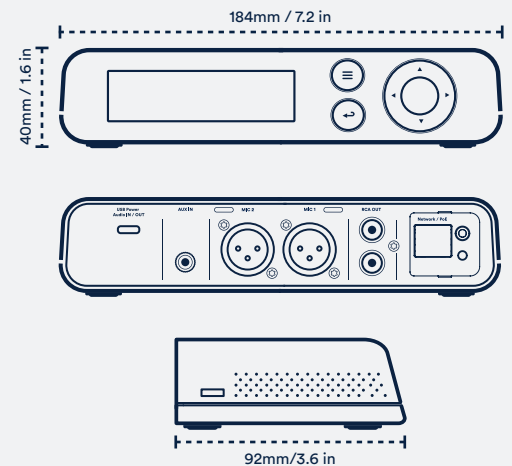

## Cube

Wireless throwable microphone that can be thrown or passed around the room for audience audio capture.

<b>Audio frequency response</b>	50 to 20000 Hz
<b>Microphone element</b>	Electret condenser, omni-directional
<b>Built-in Automute technology</b>	Yes**
<b>Battery type</b>	Li-ion, rechargeable
<b>Battery life</b>	Typical 12h***
<b>Battery charge time</b>	Catchbox Wireless charger: 6h USB-C: 3h
<b>Weight</b>	370 g / 13.05 oz
<b>Dimensions</b>	180 x 180 x 180 mm / 7 x 7 x 7 in

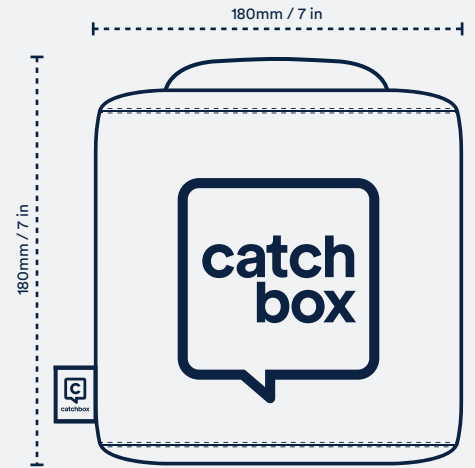

## Clip

Wireless lavalier microphone that can be clipped on or worn on the lanyard by the presenter.

<b>Audio frequency response</b>	50 to 20000 Hz
<b>Microphone element</b>	Electret condenser, omni-directional
<b>Built-in Automute technology</b>	Yes**
<b>Battery type</b>	Li-ion, rechargeable, replaceable
<b>Battery life</b>	Typical 8h***
<b>Battery charge time</b>	Catchbox Dock: 2h USB-C: 2h
<b>Attachment types</b>	Lever (clip on clothing) Lanyard (wear around the neck)
<b>Weight</b>	57 g / 2.01 oz
<b>Dimensions (with lever)</b>	40 x 72 x 28 mm / 1.57 x 2.83 x 1.10 in

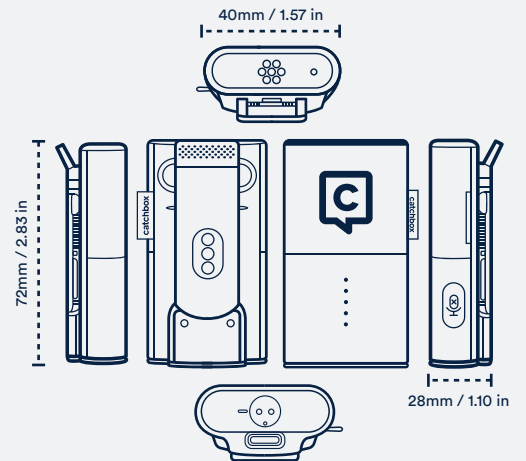

\* The actual operating range depends upon the RF output settings, the surroundings, the signal absorption, signal reflection and signal interference

\*\*\* Depends on selected RF power level

## Mounting Kit

An accessory that allows you to lock and mount the Hub on any direction oriented surface.

<b>Compatible with</b>	Hub
<b>Mounting options</b>	Dual lock for adhesion mount VESA 100mm pattern for Screw mount
<b>Cable manager</b>	Yes
<b>Weight (without mounting kit)</b>	190 g / 6.70 oz
<b>Dimensions (without mounting kit)</b>	184 x 184 x 44 mm / 7.2 x 7.2 x 1.7 in

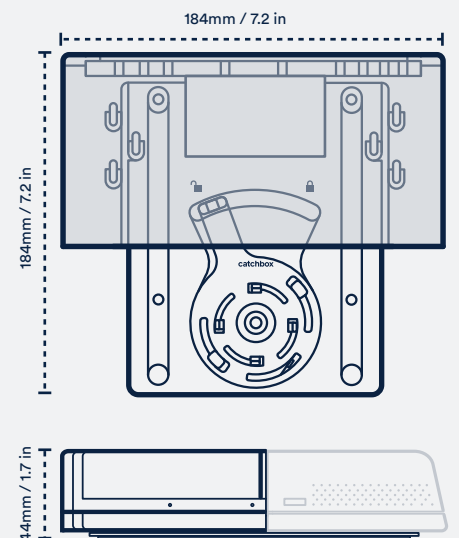

## Cube Wireless Charger

Home station for the Cube microphone.  
Place the Cube on the Wireless Charger to turn off the mic and start charging.

<b>Compatible with</b>	Cube
<b>Charging protocol</b>	Catchbox proprietary
<b>Power supply</b>	5V 1A USB-C
<b>Weight</b>	385 g / 13.6 oz
<b>Dimensions</b>	189 x 189 x 30 mm / 7.44 x 7.44 x 1.18 in

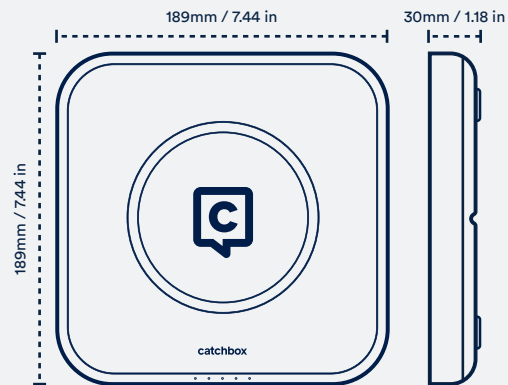

## Dock Charger

Home station for the Clip microphone. Snap the Clip on the Dock to turn off the mic and start charging.

<b>Compatible with</b>	Clip
<b>Power supply</b>	5V 1A USB-C
<b>Daisy chain</b>	Up to 4 Docks
<b>Weight</b>	150 g / 5.29 oz
<b>Dimensions</b>	95.5 x 95.5 x 25 mm / 3.76 x 3.76 x 0.98 in

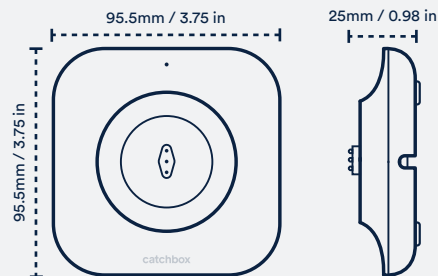

## Dock Bracket

Elevated mount for the Dock Charger. Attaches to horizontal or vertical surfaces.

<b>Compatible with</b>	Dock Charger
<b>Weight</b>	500 g / 17.64 oz
<b>Dimensions</b>	85 x 95 x 74 mm / 3.35 x 3.74 x 2.91 in

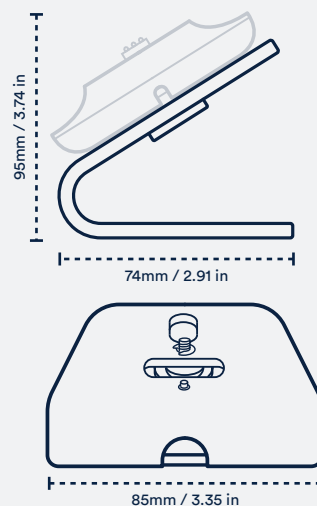

## Storage Case

Dedicated storage case for the Plus system components (Clip and Cube bundle)

<b>Compatible with</b>	Hub, Clip, Cube, Cub, Wireless Charger, Dock Charger, Dock Bracket, Mounting kit, Cables
<b>Weight</b>	3 kg / 6.61 lb
<b>Dimensions</b>	410 x 275 x 295 mm / 16.14 x 10.82 x 11.61 in

